

MONZA LINEAR

PMMA LED cooler linear lighting fixture



Features

Small and elegant size W11×H14mm.

A special optical diffuser makes the LED dots invisible.

creating a linear effect similar to that of fluorescent tubes.

Food display versions are available.

Different configurations available upon request.

Specifications / data per meter

Electrical

Power	9.6W
Input voltage	12V / 24V DC
Consumption	9.6W (Max)

LED

Type	2835
QTY	140 pcs
CCT	2700K-6500K
CRI	>80 Ra

Light Output

Beam angle	120°
Efficiency	50-60 Lm/W
Lumen	530 Lm

Food Display Versions

Meat:	CCT-Pink
Fish:	CCT-10000K
Vegetable & Fruit:	CRI>97 Ra

Working Temperature

-25°C / -35°C ~ +45°C

IP Rating

IP54

Appearance

Material	PMMA
Dimensions	L1022 x W11 x H14 mm
Max Length	3122 mm
Diffuser	Milky white

Accessories

Spring steel clips / Magnet clips / Magnetic tape

Wire Exit

Linear + 90° x 3 ways out

Mechanical Structure

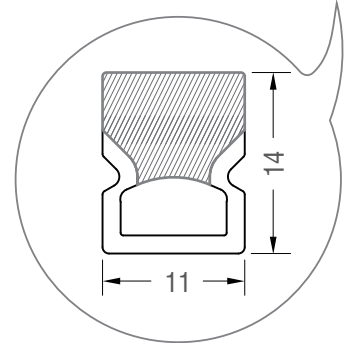
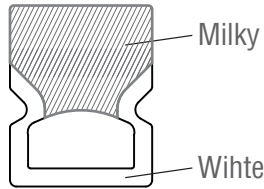
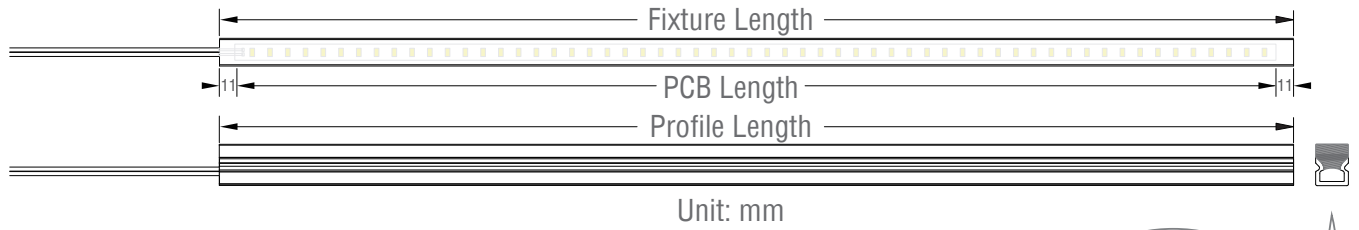

• Light fixture length rules

Fixture Length (mm)	Profile Length (mm)	PCB Length (mm)
122	122	100
177	177	150
222	222	200
277	277	250
322	322	300
377	377	350
422	422	400
477	477	450
522	522	500
577	577	550
62	622	600
677	677	650
722	722	700

Fixture Length (mm)	Profile Length (mm)	PCB Length (mm)
777	777	750
822	822	800
877	877	850
922	922	900
977	977	950
1022	1022	1000
1522	1522	1500
...		
2022	2022	2000
...		
2522	2522	2500
...		
3122	3122	3100

Installation

• Mounting

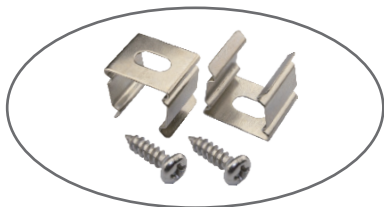

Clip with screws

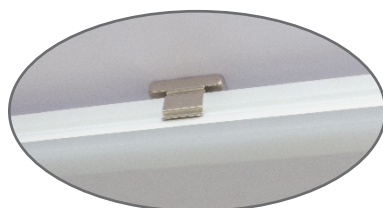
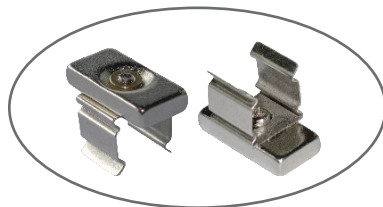

Clip with magnet

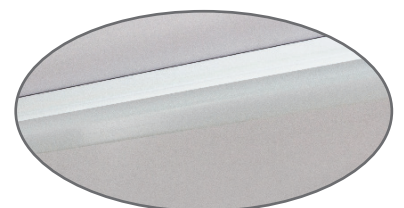

Magnetic strip

Connection Diagram

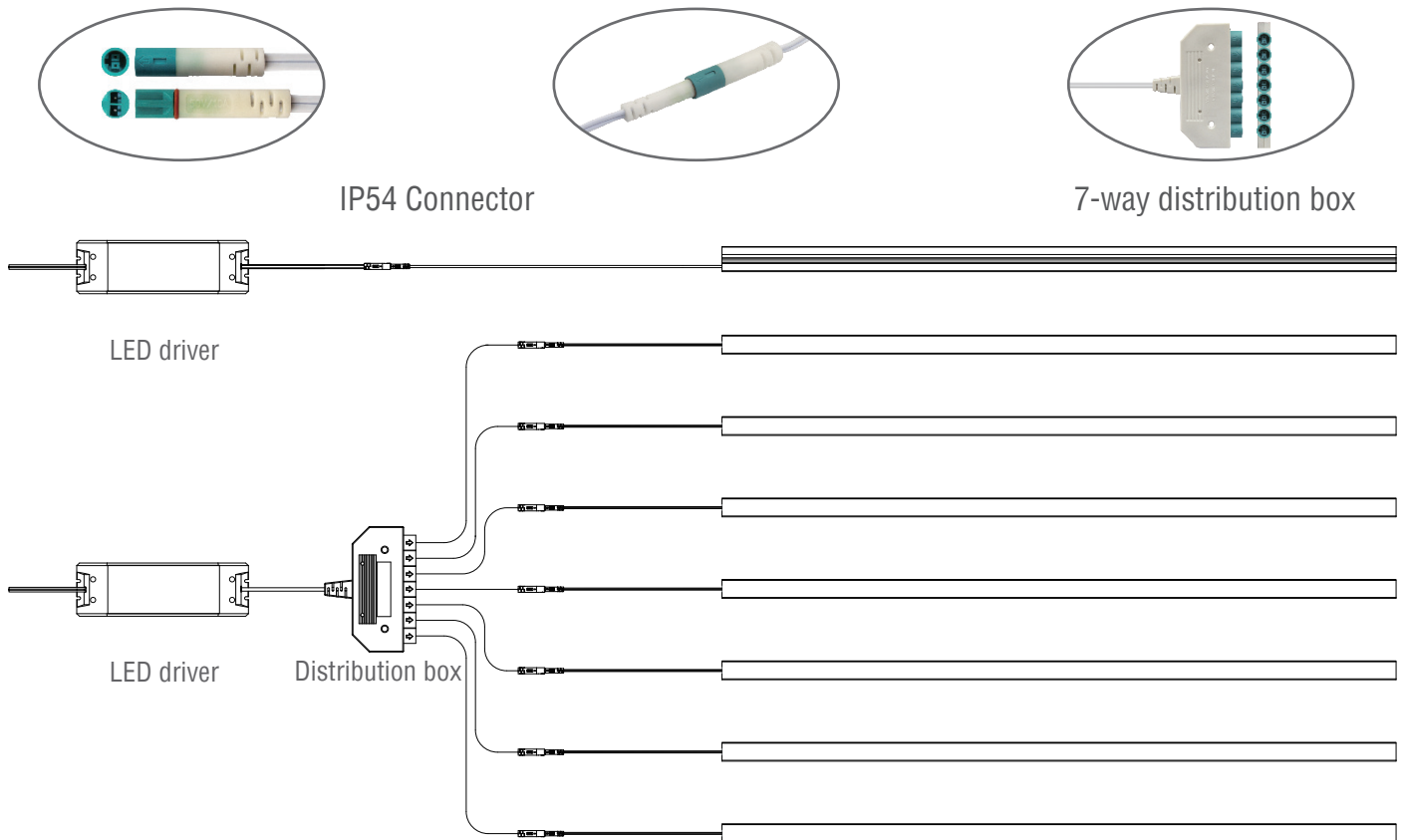

Applications

