

SIENA

PMMA LED cooler lighting fixture



Features

- Siena is designed for shelf and refrigeration display lighting.
- Mounting is easy using metal clips or magnets.
- Food display versions are available.
- Different configurations available upon request.

Specifications / data per meter

Electrical

Power	9.6W / 14.4W (HB)
Input voltage	12V / 24V DC
Consumption	14.4W (Max)

LED

Type	2835
QTY	120 pcs
CCT	2700K-6500K
CRI	>80 Ra

Light Output

Beam angle	110°
Efficiency	110-120 Lm/W
Lumen	1530 Lm

Food Display Versions

Meat:	CCT-Pink
Fish:	CCT-10000K
Vegetable & Fruit:	CRI>97 Ra

Working Temperature

-25°C / -35°C ~ +45°C

IP Rating

IP54

Appearance

Material	PMMA
Dimensions	L1030 x W17 x H8.7 mm
Max Length	2530 mm
Diffuser	Clear

Accessories

Spring steel clips / Magnet clips / Magnetic tape

Wire Exit

Linear

Mechanical Structure

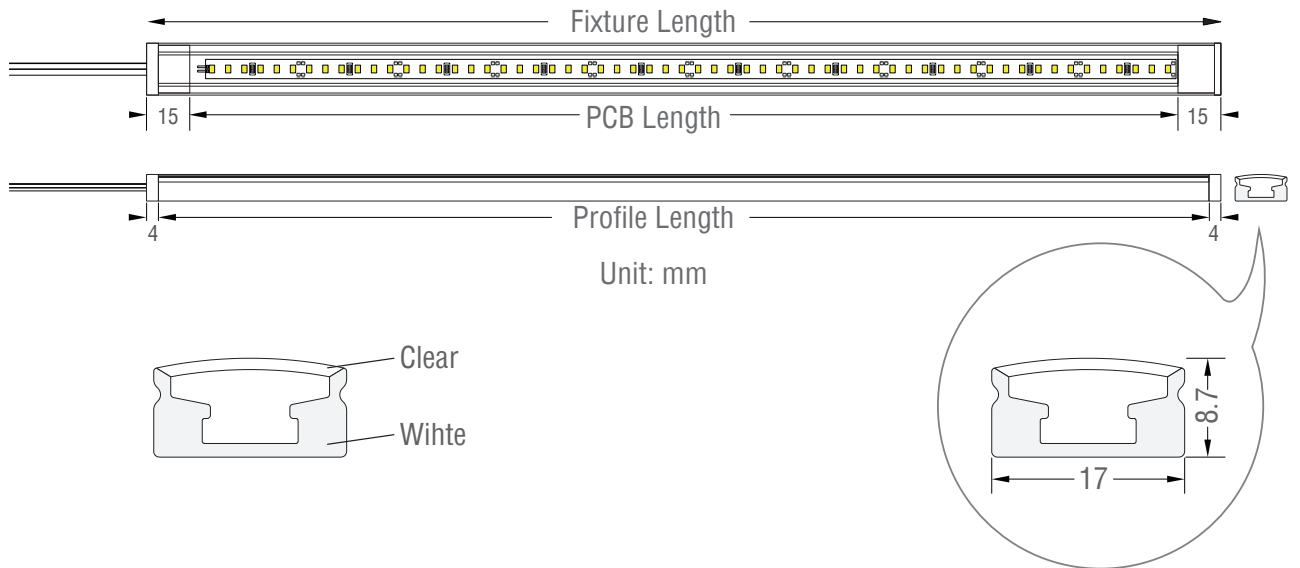

• Light fixture length rules

Fixture Length (mm)	Profile Length (mm)	PCB Length (mm)
130	122	100
180	172	150
230	222	200
280	272	250
330	322	300
380	372	350
430	422	400
480	472	450
530	522	500
580	572	550
630	622	600
680	672	650
730	722	700

Fixture Length (mm)	Profile Length (mm)	PCB Length (mm)
780	772	750
830	822	800
880	872	850
980	922	900
980	972	950
1030	1022	1000
1080	1072	1050
...		
1530	1522	1500
...		
2030	2022	2000
...		
2530	2522	2500

Installation

• Mounting

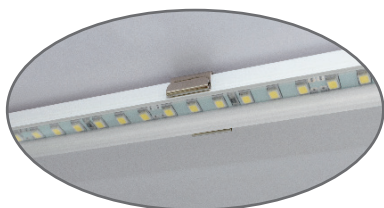
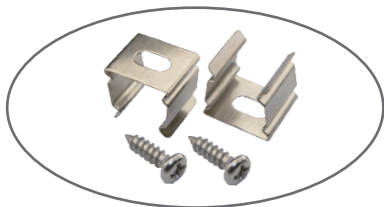

Clip with screws

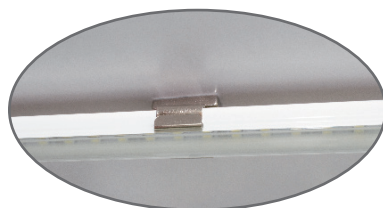
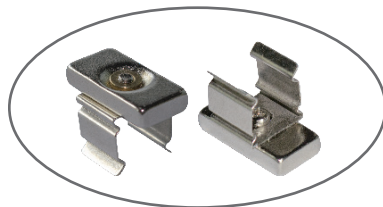

Clip with magnet

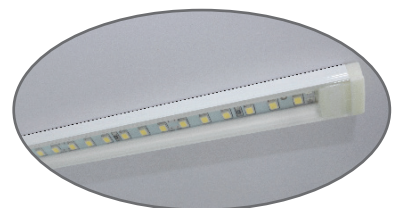

Magnetic strip

Connection Diagram

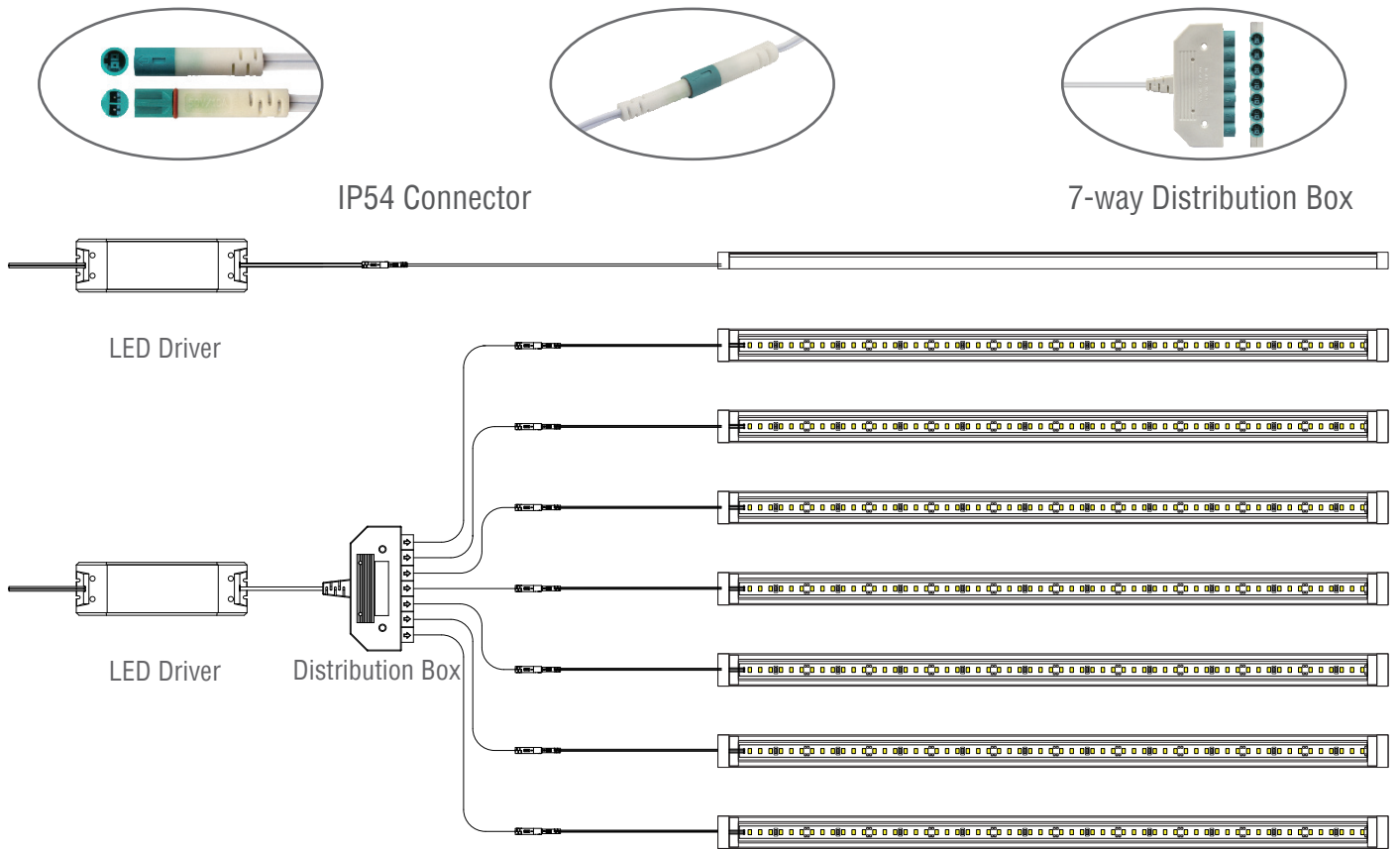

Applications

